

SOFAR

USER MANUAL

SOFAR 100~125KTLX-G4

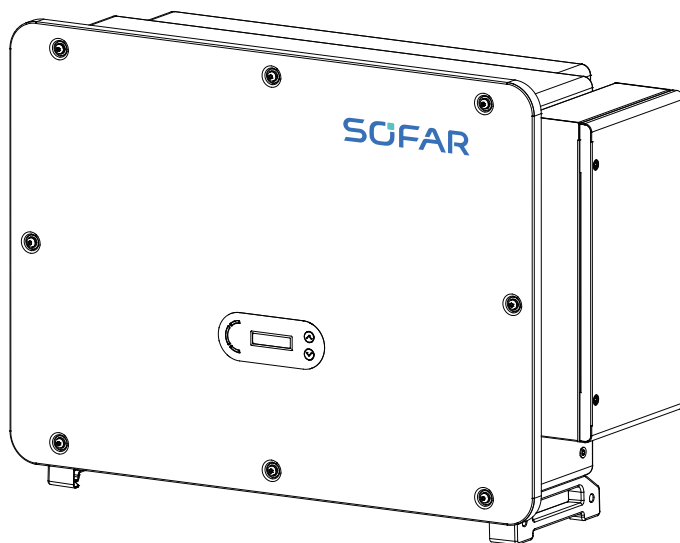

Shenzhen SOFARSOLAR Co.,Ltd.

CONTENTS

- Preface 01

- 01 Basic Safety Information 03**
 - 1.1 Requirement for Installation and Maintenance 03
 - 1.2 Symbols and Signs 06

- 02 Product Characteristics 08**
 - 2.1 Intended Use 08
 - 2.2 Function Description 09
 - 2.3 Electrical Block Diagram 10
 - 2.4 Others 11

- 03 Inverter Storage 12**

- 04 Installation 13**
 - 4.1 Installation Process 13
 - 4.2 Checking Before Installation 13
 - 4.3 Tools 15
 - 4.4 Determining the Installation Position 16
 - 4.5 Moving of Inverter 17
 - 4.6 Installation 18

05	Electrical Connection	22
5.1	Electrical Connection	23
5.2	Terminal Connector	23
5.3	Grounding Connection (PE)	24
5.4	Connect Grid Side of Inverter(AC-Output)	25
5.5	Connect PV Side of Inverter(DC-Input)	29
5.6	Communication Connection	31
06	Commissioning of inverter	36
6.1	Cable Connection Inspection	36
6.2	Start Inverter	36
07	Operation interface	37
7.1	Operation and Display Panel	37
7.2	Standard Interface	37
7.3	Main Interface	39
7.4	Updating Inverter Software	43
08	Trouble shooting and maintenance	44
8.1	Troubleshooting	44
8.2	Maintenance	50
8.3	PID Recovery	51
09	Technical Data	52
9.1	Parameter Table	52
10	Quality Assurance	54

Preface

Notice

The products, services or features you purchased shall be subject to the company's commercial contracts and terms. All or part of the products and services described in this document may not be within the scope of your purchase. Unless additional terms and conditions in your contract, the company does not make any statement or guarantee on the contents of this document.

Save this Instruction

This manual must be considered as an integral part of the equipment. Customer can print the electronic version to hard copy and keep it properly for future reference. Anyone who operates the device at any time must operate in accordance with the requirements of this manual.

Copyright Declaration

The copyright of this manual belongs to Shenzhen SOFARSOLAR Co., Ltd. Any corporation or individual should not plagiarize, partially copy or fully copy (including software, etc.), not allow to duplication and publication in any form and any way. All rights reserved, SOFARSOLAR reserves the right of final interpretation. This manual is subject to modification according to user's or customer's feedback. Please check our website at www.sofarsolar.com for the latest version.

Document Updates

V1.0 20230207

Initial version

Outline

This manual is an integral part of SOFAR 100~125KTLX-G4. It describes the assembly, installation, commissioning, maintenance and failure of the product. Please read it carefully before operating.

Scope of Validity





This manual contains important instructions for: SOFAR 100KTLX-G4; SOFAR 110KTLX-G4; SOFAR 125KTLX-G4; SOFAR 125KTLX-G4-A.

Target Group

This manual is for qualified electricians. The tasks described in this manual can only be performed by qualified electricians.

Symbols Used

The following types of safety instruction and general information appear in this document as described below:

	 Danger	“Danger” indicates a hazardous situation which, if not avoided, will result in death or serious injury.
	 Warning	“Warning” indicates a hazardous situation which, if not avoided, could result in death or serious injury
	 Caution	“Caution” indicates a hazardous situation which, if not avoided, could result in minor or moderate injury
	 Attention	“Attention” indicates there are potential risks, if fail to prevent, may lead to equipment cannot normally or property damage
	 Note	“Note” provides additional information and tips that are valuable for the optimal operation of the product

1. Basic Safety Information

Outlines of this Chapter

Please read the instruction carefully. Faulty operation may cause serious injury or death.



Note

If you have any question or problem when you read the following information, please contact Shenzhen SOFARSOLAR CO., Ltd.

Safety Instruction

Introduce the safety instruction during installation and operation of SOFAR 100~125KTLX-G4.

Symbols Instruction

This section gives an explanation of all the symbols shown on the inverter and on the type label.

1.1 Requirement for Installation and Maintenance

- Installation of SOFAR 100~125KTLX-G4 on-grid inverter must conform with laws, regulations, codes and standards applicable in the jurisdiction.
- Before installing and adjusting the produce, please read all of instructions, cautions and warnings in this manual
- Before connecting the product to the electrical utility grid, contact the local utility company for allowance. Also, this connection must be made only by qualified electrician.
- If the failure persists, please contact the nearest authorized maintenance center. If you don't know which service center is closest to you, please contact your local distributor. Don't repair the product by yourself, which may lead serious injury or damage.

Qualified Person

When inverter is working, it contains lethal voltages and went hot in some area. Improper installation or misoperation could cause serial damage and injury. To reduce the risk of personal injury and to ensure the safe installation and operation of the product, only a qualified electrician is allowed to execute transportation, installation, commissioning and maintenance. Shenzhen SOFARSOLAR Co, Ltd. does not take any responsibility for the property destruction and personal injury because of any incorrect use.

Label and Symbols

SOFAR 100~125KTLX-G4 has type label attach the side of product which contact important information and technical data, the type label must permanent attached to the product.

SOFAR 100~125KTLX-G4 has warning symbol attache the product which contact information of safety operation. The warning symbol must permanent attached to the product.

Installation location requirement

Please install the inverter according to the following section. Place inverter in an appropriate bearing capacity objects (such as solid brick wall, or strength equivalent mounting surface, etc.) and make sure inverter vertical placed. A proper installation location must have enough space for fire engine access in order for maintenance if faulty occur. Ensure the inverter is installed in a wall ventilated environment and have enough air cooling cycle. Air humidity should less than 90%.

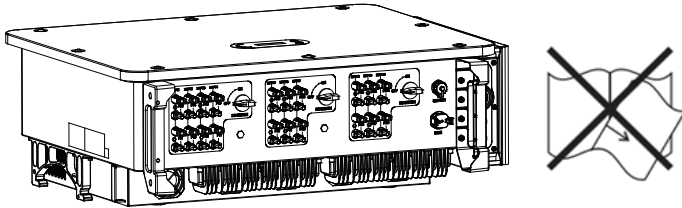



Transportation Requirement

Inverter is in the good electrical and physical condition when it ship out from factory. During transport, inverter must be placed in its original package or other proper package. Transportation company should responsible for any damage during transport period.



If you find any packing problems that may cause the damage of inverter or any visible damage, please notice the responsible transportation company immediately. You can ask your installer or SOFARSOLAR for help is necessary.

Electrical Connection



Please comply with all the current electrical regulations about accident prevention in dealing with the current inverter.

 Danger	Before the electrical connection, use opaque material to cover the PV modules or disconnect PV string DC switch. PV arrays will produce dangerous voltage if it is exposure under sun.
 Warning	All operation must accomplish by certified electrical engineer <ul style="list-style-type: none"> • Must be trained; • Completely read the manual operation and understand all information.
 Attention	Must get permission by local utility company before connecting to grid and the connection must be done by certified electrical engineers.

Operation

 Danger	<p>Touching the utility grid or the terminal conductors can lead to lethal electric shock or fire!</p> <p>Do not touch non-insulated cable ends, DC conductors and any live components of the inverter.</p> <p>Attention to any electrical relevant instruction and document.</p>
 Attention	<p>Enclosure or internal components may get hot during operation. Do not touch hot surface or wear insulated gloves.</p> <p>Keep it away from kids!</p>

Maintenance and repair

 Danger	<p>Before any repair work, turn OFF the AC circuit breaker between the inverter and electrical grid first, then turn OFF the DC switch.</p> <p>After turning OFF the AC circuit breaker and DC switch wait for at least 5 minutes before carry any maintenance or repair work.</p>
 Attention	<p>Inverter should not work again until removing all faults. If any repair work is required, please contact local authorized service center.</p> <p>Should not open the inverter cover without authorized permit, SOFARSOALR does not take any responsibility for that.</p>





EMC/Noise Level

Electromagnetic compatibility (EMC) refers to that on electrical equipment functions in a given electromagnetic environment without any trouble or error, and impose no unacceptable effect upon the environment. Therefore, EMC represents the quality characters of an electrical equipment.

- The inherent noise-immune character: immunity to internal electrical noise
- External noise immunity: immunity to electromagnetic noise of external system
- Noise emission level: influence of electromagnetic emission upon environment



 Danger	<p>Electromagnetic radiation from inverter may be harmful to health!</p> <p>Please do not continue to stay away from the inverter in less than 20cm when inverter is working</p>
------------------------------------------------------------------------------------------------------	----------------------------------------------------------------------------------------------------------------------------------------------------------------------------------







1.2 Symbols and signs

 Danger	High voltage of inverter may be harmful to health! Only certified engineer can operate the product; Juveniles, Disable, should not use this product; Keep this product out of the reach of children;
 Caution	Caution of burn injuries due to hot enclosure! Only touch the screen and pressing key of the inverter while it is working
 Attention	PV array should be grounded in accordance to the requirements of the local electrical grid company
 Warning	Ensure the maximum DC voltage input is less than the maximum inverter DC voltage (including in low temperature condition). Any damage cause by overvoltage, SOFARSOLAR will not take the responsibility including warranty

Signs on the Product and on the Type Label

SOFAR 100~125KTLX-G4 has some safety symbols on the inverter. Please read and fully understand the content of the symbols before installation.

Symbols	Name	Explanation
	This is a residual voltage in the inverter	After disconnect with the DC side, there is a residual voltage in the inverter, operator should wait for 5 minutes to ensure the capacitor is completely discharged.
	Caution of high voltage and electric shock	The products operates at high voltages. Prior to performing any work on the product, disconnect the product from voltage sources. All work on the product must be carried out by qualified persons only.

	<p>Caution of hot surface</p>	<p>The product can get hot during operation. Avoid contact during operation. Prior to performing any work on the product, allow the product to cool down sufficiently</p>
	<p>Comply with the Conformite Europeenne (CE) Certification</p>	<p>The product comply with the CE Certification</p>
	<p>Grounding Terminal</p>	<p>This symbol indicates the position for the connections of an additional equipment grounding conductor</p>
	<p>Observe the documentation</p>	<p>Read all documentation supplied with the product before install</p>
	<p>Positive pole and negative pole</p>	<p>Positive pole and negative pole of the input voltage (DC)</p>
	<p>Temperature</p>	<p>Indicated the temperature allowance range</p>
	<p>RCM logo</p>	<p>RCM (Regulatory Compliance Mark) The product complies with the requirements of the applicable Australian standards.</p>

2. Product Characteristics

Outlines of this Chapter

Product Dimensions

Introduce the field of use and the dimensions of the product

Function Description

Introduce working principle and internal components

Electrical block diagram

Introduce the electrical block diagram of the product

2.1 Intended Use

SOFAR 100~125KTLX-G4 is a transformerless on grid PV inverter, that converts the direct current of the PV array to the grid-compliant, three-phase current and feeds into the utility grid.

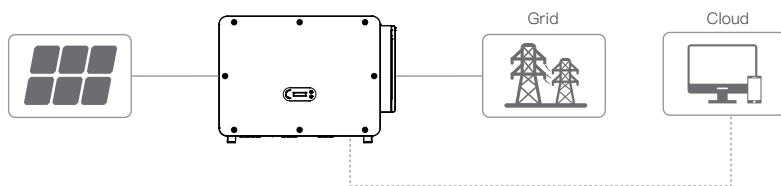

Figure 2-1 PV Grid-Tied System

SOFAR 100~125KTLX-G4 may only be operated with PV arrays (photovoltaic module and cabling) for on grid condition. Do not use this product for any other or additional purposes. Any damage or property loss due to any use of the product other than described in this section, SOFARSOLAR will not take the responsibility. DC input of the product must be PV module, other source such like DC sources, batteries will against the warranty condition and SOFARSOLAR will not take the responsibility.

Product Dimensions

The choice of optional parts of inverter should be made by a qualified technician who knows the installation conditions clearly.

Dimensions Description

- SOFAR 100~125KTLX-G4
LxWxH=970*695*325mm

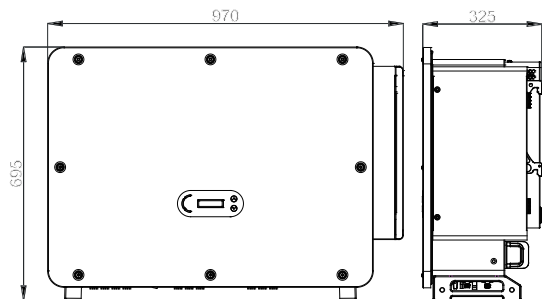

Figure 2-2 Product front view and left view dimensions

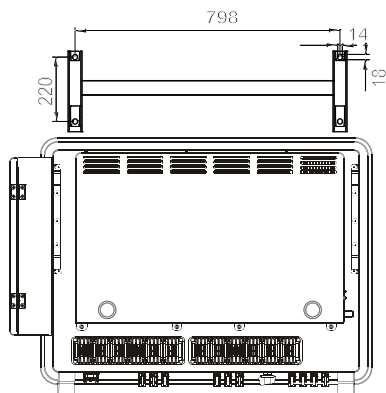

Figure 2-3 Product back view and bracket dimensions

Labels on the equipment

Note: label must NOT be hidden with objects and extraneous parts (rags, boxes, equipment, etc.); they must be cleaned regularly and kept visible at all times.

SGFAR	Solar Grid-Tied Inverter
Model	SOFAR 110KTLX-G4
Max DC Input Voltage	1100V
Operating MPPT Voltage Range	180~1050V
Max Input Current	10/40A
Max PV Ins.	10/950A
Rated Output Voltage	3/N/PE, 220/380Vac
	230/400Hz, 50/60/15/30
Max. Output Current	187.2A/380Vac
	159.5A/400Vac
Rated Output Frequency	50/60Hz
Rated Output Power	110kW
Max. Output Apparent Power	110kVA
Power Factor	Adjustable(+0.8)
Ingress Protection	IP65
Operating Temperature Range	-30°C~+50°C
Inverter Topology	Non-Isolated
Protection Class	Class I
Overvoltage Category	AC III, DC II
Made in China	
Manufacturer: Shenzhen SOFARSOLAR Co., Ltd. Address: 11/F, Gaoteng Technology Building, No.67 Area, Bingting Community, Xixun Road District, Bao'an District, Shenzhen City, China	

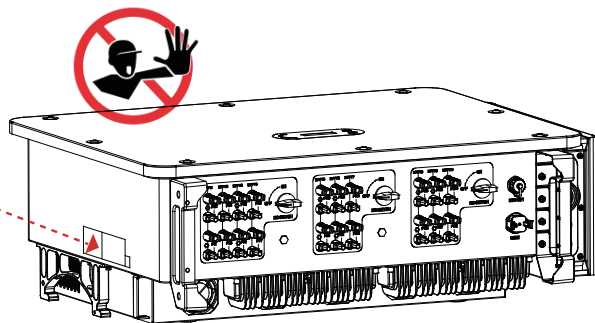

Figure 2-4 Product label

2.2 Function Description

DC power generated by PV arrays is filtered through Input Board then enter Power Board. Input Board also offer functions such as insulation impedance detection and input DC voltage/ current detection. DC power is converted to AC power by Power Board. AC power is filtered through

Output Board then AC power is fed into the grid. Output Board also offer functions such as grid voltage/ output current detection, GFCI and output isolation relay. Control Board provides the auxiliary power, controls the operation state of inverter and shows the operation status by Display Board. Display Board displays fault code when inverter is abnormal operation conditions. At the same time, Control Board can trigger the replay to protect the internal components.

Function Module

A. Energy management unit

Remote control to start/ shunt down inverter through an external control.

B. Feeding reactive power into the grid

The inverter is able to produce reactive power thus to feed it into the grid through the setting of the phase shift factor. Feed-in management can be controlled directly by the grid company through a RS485 interface.

C. Limited the active power fed into grid

If enable the limited of active power function, inverter can limit the amount of active power fed into the grid to the desired value (expressed as percentage).

D. Self-power reduction when grid is over frequency

If grid frequency is higher than the limited value, inverter will reduce the output power to ensure the grid stability.

E. Data transmission

Inverter or a group of inverters can be monitored remotely through an advanced communication system based on RS485 interface or via WiFi/Ethernet.

F. Software update

USB interface for uploading the firmware, remotely uploading is available.

G. PID recovery

The PID effect can be recovered at night to protect the PV modules.

2.3 Electrical block diagram

SOFAR 100~125KTLX-G4 has 20 DC input strings. 10 MPPT trackers that converts the direct current of PV array to grid-compliant, three phase current and feeds in into the utility grid. Both DC and AC side has Surge Protection Device (SPD).

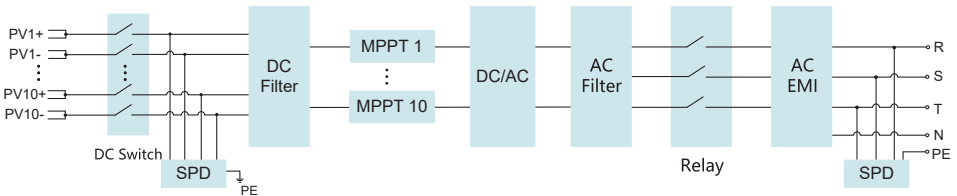

Figure 2-5 Electrical block diagram

2.4 Others

- Initial short-circuit AC current is 756.7A-peak
- As indicated in VDE-AR-N 4105:2018-11, section 6 Construction of the power generation system/network and system protection (NS protection), the requirements for the network and system protection differ depending on the maximum apparent power($S_{Amax}\Sigma S_{Amax}$) of the generating and storage units connected to the same network connection point.
- For installations with $S_{Amax}\Sigma S_{Amax} \leq 30kVA$, the NS protection can either be
 - A. a central NS protection at the central meter panel or decentralized in a sub-distribution; or
 - B. integrated NS protection
- The equipment models covered by this manual are all below this limit and both of these options can be chosen.
- For installations with $S_{Amax}\Sigma S_{Amax} > 30kVA$, the NS protection must be accomplished by a central NS protection device at the central meter panel.

In the case, taking into account the equipment covered by this User Manual, this situation will happen when several units are connected to the same network connection point.

Note: the NS protection shall meet that a single fault shall not lead to a loss of the protective function (single fault tolerance). The output is switched off redundant by the high power switching bridge and two relay in series. This assures that the opening of the output circuit will also operate in case of one error. AC Relay Model HF167F-200, 830Vac/200A.

All models have been performed without an additional relay connected during VDE4105:2018 certification, to check the internal protection of the equipment.

3. Inverter Storage

If inverter is not installing immediately, storage condition need meet below requirements:

- Place inverter into the original package and leave desiccant inside, sealed tight with taps.
- Keep the storage temperature around $-40^{\circ}\text{C}\sim 70^{\circ}\text{C}$, Relative humidity $0\sim 95\%$, no condensation

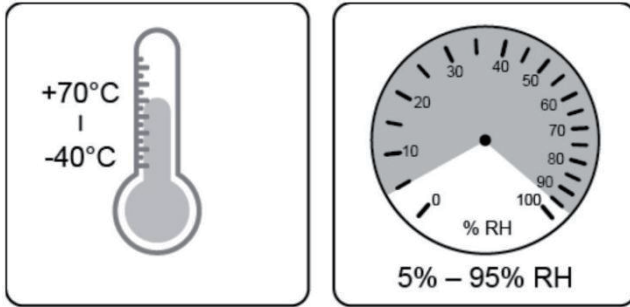





Figure 3-1 Storage temperature and humidity

- The maximum stacking layer number cannot exceed 4 layers.
- If the inverter be storage for more than half years, the inverter needs to be fully examined and tested by qualified service or technical personnel before using.

4.Installation

Outlines of this Chapter

This topic describes how to install this product, please read carefully before install.

	 Danger	Do not install the product on flammable material. Do not store this product in potentially explosive atmospheres.
	 Caution	The enclosure and heat sink will get hot during operation, please do not mount the product at a easy to reach location.
	 Attention	Consider the weight of this product when doing transport and moving. Choose an appropriate mounting position and surface. At least two persons for installation.

4.1 Installation Process



4.2 Checking Before Installation



Checking Outer Packing Materials

Before unpacking, please check the condition of the outer package materials if any damaged found, such as holes, cracks, please not unpack the product, contact your distributor immediately. Recommend installing the product within 24 hours after unpacking the package.

Checking Deliverable



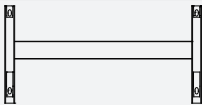
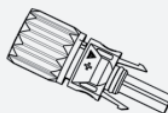
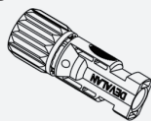
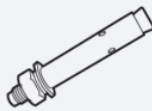

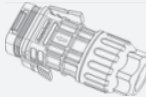
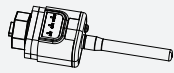





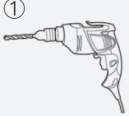
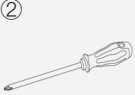
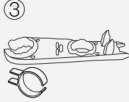

After unpacking, please check according to following table, to see whether all the parts were included in the packing, please contact your distributor immediately if anything missing or damage.

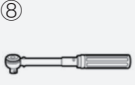
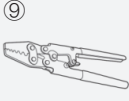
Table 4-1 Components and mechanical parts that inside the package

	<p>① SOFAR 100~125KTLX-G4 x1 pcs</p>		<p>② Rear Panel x1 pcs</p>
	<p>③ PV+ input connector x20 pcs</p>		<p>④ PV- input connector x20 pcs</p>
	<p>⑤ PV+ metal pin x20 pcs</p>		<p>⑥ PV- metal pin x20 pcs</p>
	<p>⑦ M10*90 Hexagon screws x4 pcs</p>		<p>⑧ M6*30 Hexagon screws x2 pcs</p>
	<p>⑨ Manual x1 pcs</p>		<p>⑩ Warranty Card x1 pcs</p>
	<p>⑪ Outgoing inspection report x1 pcs</p>		<p>⑫ Quality Certificate x1 pcs</p>
	<p>⑬ COM 16pin connector x1 pcs</p>		<p>⑭ USB collection (WiFi / Ethernet)) x1 pcs</p>

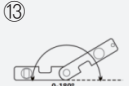
4.3 Tools

Prepare tools required for installation and electrical connection as following table:
Table 4-2 Installation tools

	<p>Description: Hammer Drill Recommend drill @ 10mm</p> <p>Function: Used to drill holes on the wall</p>		<p>Description: Screwdriver</p> <p>Function: Use to tighten and loosen screws when installing AC power cable Use to remove AC connectors from the product</p>
	<p>Description: Removal Tool</p> <p>Function: Remove PV Connector</p>		<p>Description: Wire Stripper</p> <p>Function: Used to peel cable</p>
	<p>Description: With an open end of larger than or greater than 32 mm</p> <p>Function: Used to tighten expansion bolts</p>		<p>Description: Rubber Mallet</p> <p>Function: Used to hammer expansion bolts into holes</p>
	<p>Description: M6</p> <p>Function: M6 use to uninstall and install the front top cover and down cover</p>		<p>Description: Torque wrench</p> <p>Function: Connect AC connector</p>
	<p>Description: Crimping Tool</p> <p>Function: Use to crimp cable on grid side, load side and CT extensive cable</p>		<p>Description: Multimeter</p> <p>Function: Check grounding cable, PV positive and negative pole</p>
	<p>Description: Marker</p> <p>Function: Mark signs</p>		<p>Description: Measuring Tape</p> <p>Function: Measure distance</p>
	<p>Description: Level</p> <p>Function: Ensure the rear panel is properly installed</p>		<p>Description: ESD gloves</p> <p>Function: Installer wear when installing product</p>
	<p>Description: Safety goggles</p> <p>Function: Installer wear when installing product</p>		<p>Description: Mask</p> <p>Function: Installer wear when installing product</p>

4.4 Determining the Installation Position

Select a appropriate location to install the product to make sure the inverter can work in a high efficiency condition. When selecting a location for the inverter, consider the following:

Note: Install vertical or backward tilt within 0–75°, Do not install forward or upside down!

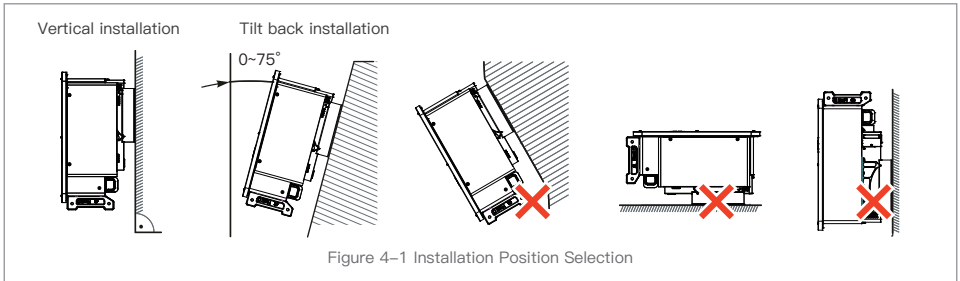
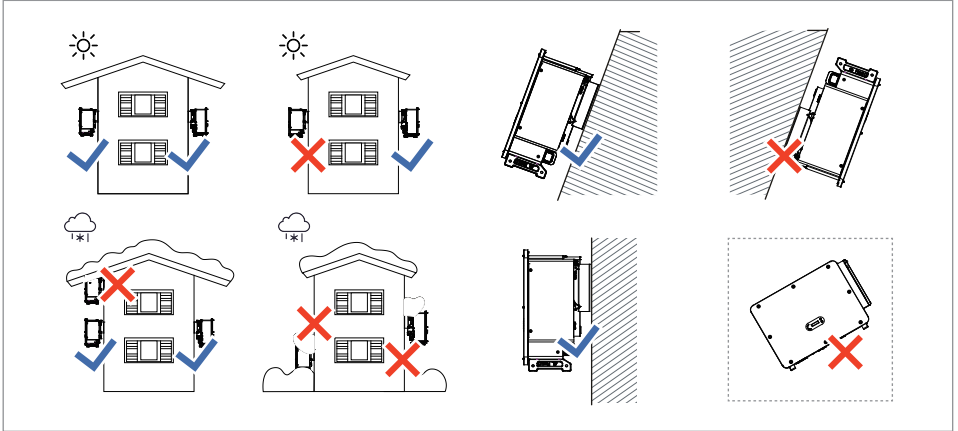

Figure 4-1 Installation Position Selection

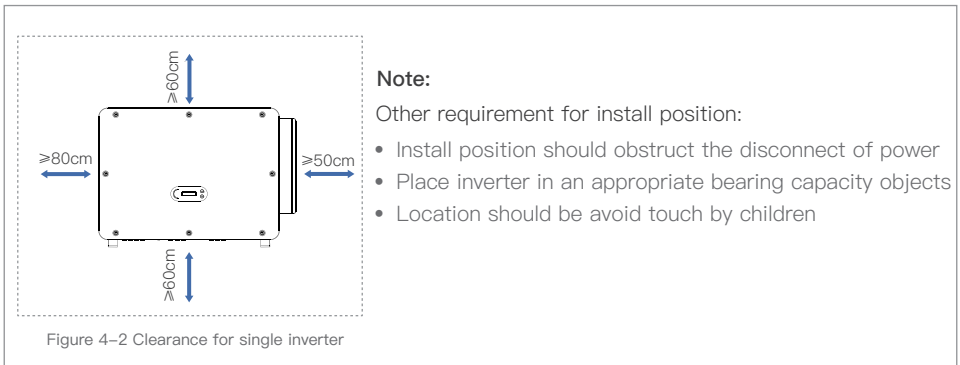
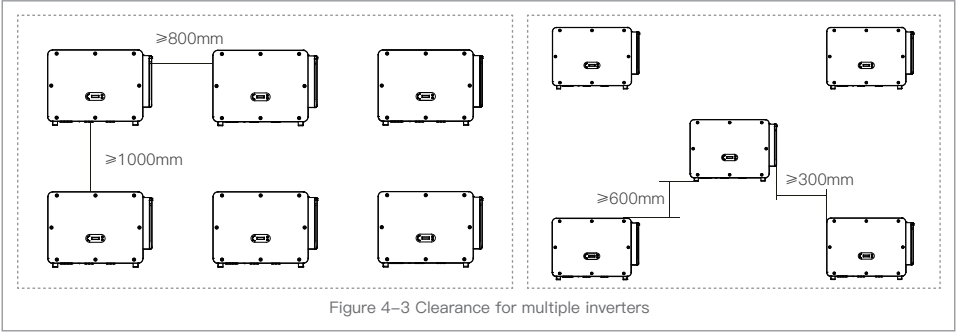

Figure 4-2 Clearance for single inverter



4.5 Moving of inverter

Manual handling

Unload the inverter from package, horizontally move to the install position. When open the package, at least two operator insert the hands into the slots on both side of the inverter and hold the handles.

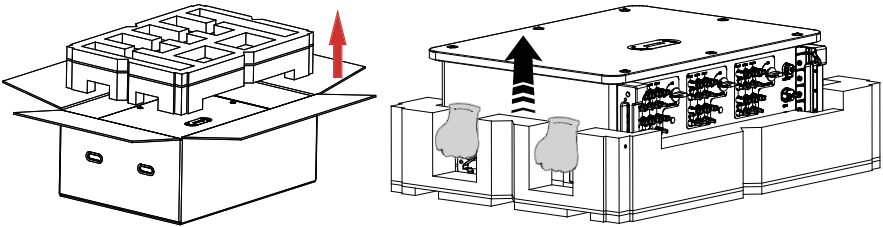

Figure 4-4 Move inverter from package



Attention

Keep the balance when lift the inverter. Required at least two operators for lifting or use forklift. Inverter is heavy, dropped while being transported may cause injuries.
 Do not put the inverter with wiring terminals contacting the floor because the power ports and signal ports are not designed to support the weight of the inverter.
 When place inverter on the floor, put it above foam or paper to avoid the damage of the shell of inverter.

4.6 Installation

Installed on wall

Step 1: Placed the rear panel on the mounting wall, determine the mounting height of the bracket and mark the mounting poles accordingly. Drilling holes by using Hammer Drill, keep the hammer drill perpendicular to the wall and make sure the position of the holes should be suitable for the expansion bolts.

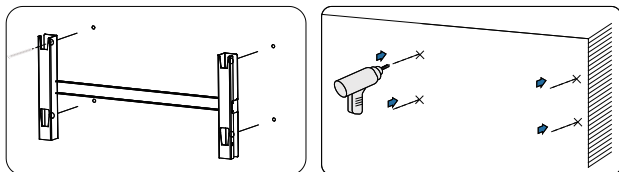

Figure 4-5 Drilling holes on the mounting wall

Step 2: Insert the expansion bolt vertically into the hole.

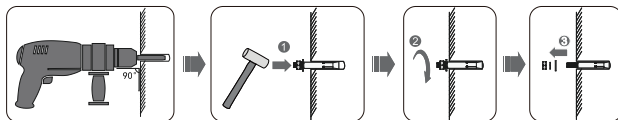

Figure 4-6 Screws into the holes

Step 3: Align the rear panel with the hole positions, fix the rear panels on the wall by tightening the expansion bolt with the nuts.

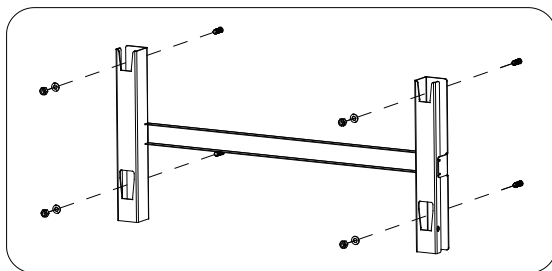

Figure 4-7 Install rear panel

Step 4: Lift the inverter and hang it on the rear panel, and fixing both side of inverter with M6 screw (accessories).

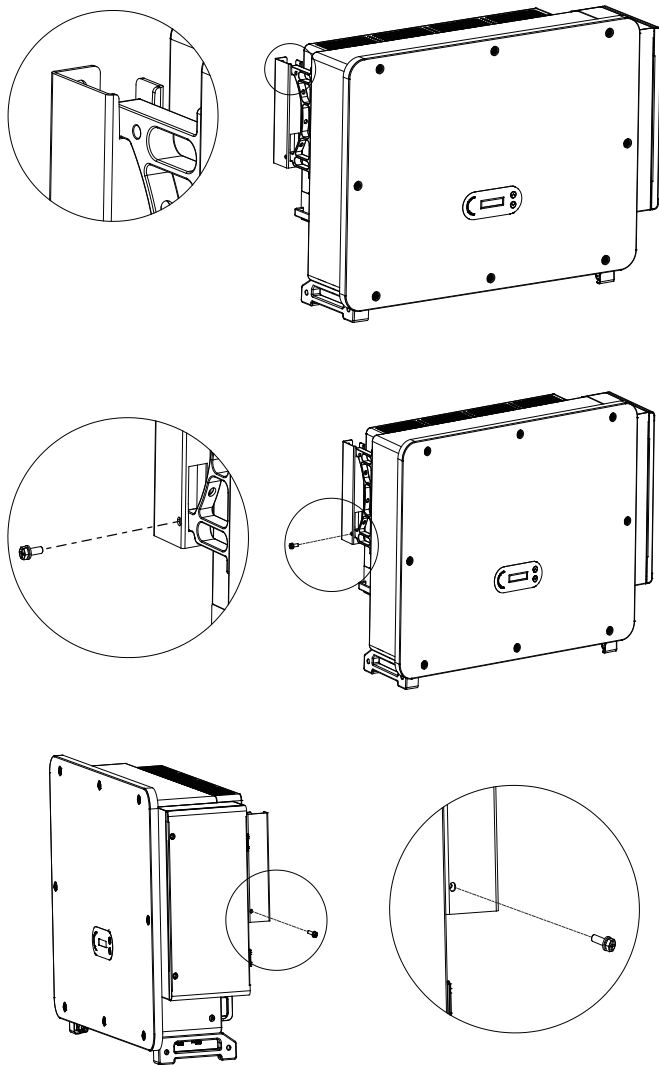

Figure 4-8 Fix inverter

Bracket Installation:

Step 1: Use wall mount bracket, ensure the pole position are in same level by using level rule and take a mark with maker.

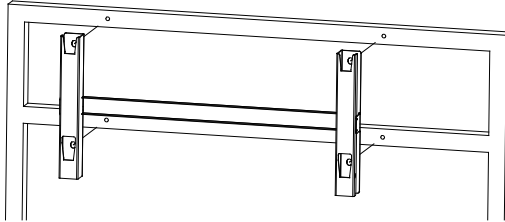

Figure 4-9 Ensure hole position

Step 2: Drilling hole by using Hammer Drill, recommend to do a stain proofing.

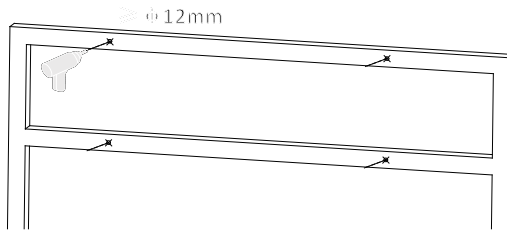

Figure 4-10 Drilling holes

Step 3: Use M10 screw and M10 flat washer to secure the wall bracket (Note: M10*50 screw and M10 flat washer need self-preparation).

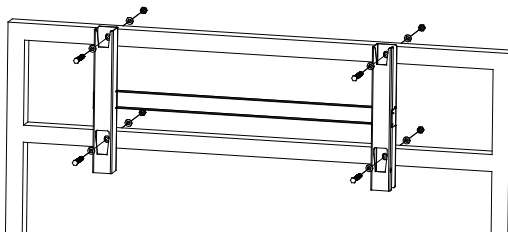
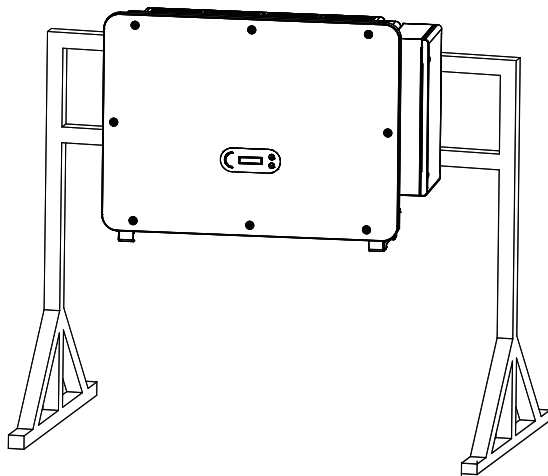

Figure 4-11 Fix wall bracket

Step 4: Lift the inverter and hang it on the wall bracket, and fixing both side of Inverter with M6 screw. Repeat 4.6.1step4



Note: The stand must be firmly anchored to the ground to avoid shaking and tipping.



5. Electrical Connection

Outlines of this Chapter

This section introduces the electrical connection for the product. Please read the information carefully, it may be helpful to understand the grounding wiring, DC input connection, AC output connection and communication connection.

Caution:

Before performing electrical connections, ensure the DC switch is OFF and AC circuit breaker is OFF. Waiting 5 minutes for the capacitor to be electrically discharged.

 Attention	Installation and maintenance should be done by certified electrical engineer
 Danger	Before the electrical connection, use opaque material to cover the PV modules or disconnect PV string DC switch. PV arrays will produce dangerous voltage if it is exposed under sun
 Note	For this product, the open circuit voltage of PV strings should not be greater than 1100V

- **Electrical Connection**
Introduce the electrical connection process.
- **Terminal Port**
Introduce inverter terminal port layout.
- **Grounding Protection (PE)**
Connect PE line for grounding protection.
- **Connect AC output (AC-Output)**
Connect AC output for feeding generated electrical into the utility grid. Must meet the requirement of local utility grid company.
- **DC input connection**
Connect PV array with inverter by DC cable.
- **Communication Connection**
Introduce the proposed USB/WIFI, COM and how to connect USB/WIFI port.
- **Safety check**
Before operating inverter, check the PV array, inverter DC side safety connection and AC side safety connection.

5.1 Electrical Connection

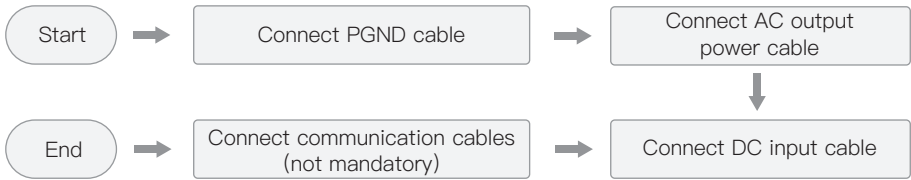

5.2 Terminal Connector

Connector description as below:

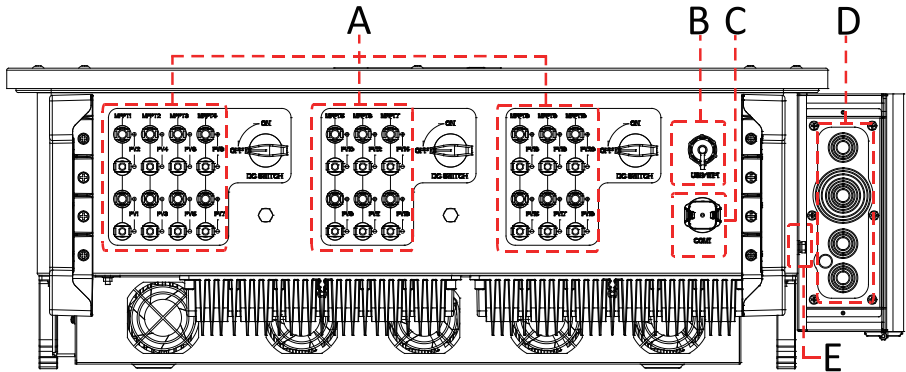

Figure 5-1 Introduction to terminal blocks

*Take picture as reference

No.	Name	Mark	Description
A	DC input terminals	PVX+/PVX-	PV connector
B	USB/WIFI port	USB/WIFI	For WiFi Communication
C	RS485 Modbus/DRMs	RS485/DRMs	RS485 Communication port/DRMs port
D	AC output terminals		AC output terminal
E	Grounding		Connecting terminal of the ground, choose at least one for grounding connection

5.3 Grounding Connection (PE)

Connect the inverter to the grounding electrode using ground cable.



Note

SOFAR 100~125KTLX-G4 is a transformerless inverter which requires the positive pole and negative pole of the PV array are NOT grounded. Otherwise, it will cause inverter failure. In the PV system, all non-current-carrying metal parts (such as mounting frame, combiner box enclosure, etc.) should be connected to earthed.

Preparation: prepare the grounding cable (recommend 16mm² yellow-green outdoor cable and M8 OT Terminal)

Procedure:

Step 1: Remove the insulation layer with an appropriate length using a wire stripper shown as figure 5-2.

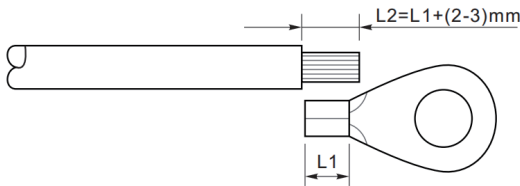

Figure 5-2 Grounding connection instruction (1)

Note: the length of L2 should 2~3mm higher than L1.

Step 2: Insert the exposed core wires into the OT terminal and crimp them by using a crimping tool, as shown as figure 5.3. Recommend using OT terminal: OT M6, Cable: ≥6mm².

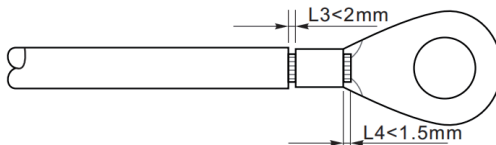
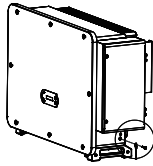

Figure 5-3 Grounding connection instruction (2)

Note 1: L3 is the length between the insulation layer of the ground cable and crimped part. L4 is the distance between the crimped part and core wires protruding from the crimped part.

Note 2: The cavity formed after crimping the conductor crimp strip shall wrap the core wires completely. The core wires shall contact the terminal closely.

Step 3: Remove the screw from the bottom side of inverter (Shown as figure 5-4), connect the grounding cable to the grounding point and tighten the grouping screw. Torque is 6-7N.m.



A.M8 hexagon screw

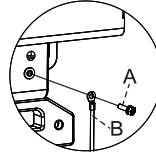

B. grounding cable

Figure 5-4 Inverter external grounding instruction diagram

Note : For improving anti-corrosion performance, after ground cable installed, apply silicone or paint is preferred to protect.

5.4 Connect Grid Side of Inverter(AC-Output)

For Belgium, one of the following links is required for external AC relay.
http://www.synergriid.be/download.cfm?fileId=C10-21_DecouplingRelays_NF_20200515.pdf
 Inverter has a standard and integrated residual current monitoring unit (RCMU), when inverter detected leakage current excess 300mA, it will cut off with utility grid for protection. For external Residual Current Device (RCD), the rated residual current shall be 300mA or higher.

Precondition:

- Inverter AC side should connect a three phase circuit current to ensure inverter can be cut off with utility grid for abnormal condition.
- The AC cable need to meet the requirement of local grid operator.

5.4.1 Open the wiring box

Note:

- Forbid to open then main board cover of inverter.
- Before open the wiring box, please ensure there is not DC and AC connection.
- If open the wiring box on snowing or raining day, please take protective measures to avoid the snow and rain enter wiring box. Otherwise, should not open the wiring box.
- Please do not unused screw in the wiring box.

Step 1: Use M6 driver to unscrew the two screws on the wiring box.

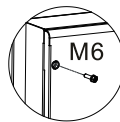
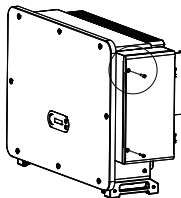

Step 2: Open wiring box cover.

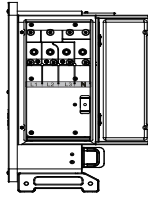

Figure 5-5 Open wiring box

5.4.2 Wiring Terminal and Precautions

Note:

- Before connect to grid, please ensure the grid voltage and frequency of local grid meet the requirement of inverter , any question please seek local grid company for help.
- Inverter can only connect to grid after get the permission from local grid company.
- Should not connect any loads between inverter and AC circuit breaker.

OT/DT Requirement:

- When use copper core cable, please use copper terminal connector.
- When use copper clad aluminum cable, please use copper terminal connector.
- When use aluminum core cable, please use Copper and aluminum transition terminal connector or aluminum terminal connector.

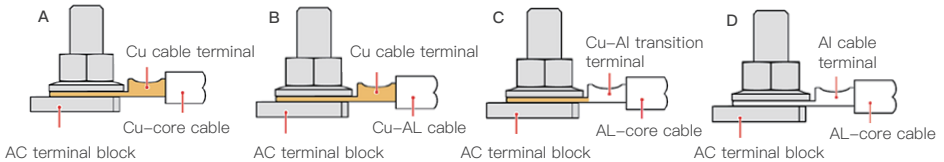

Figure 5-6 OT/DT Requirement for terminal connection

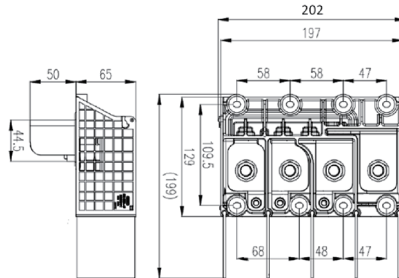

Figure 5-7 AC Terminal size

5.4.3 Wring Procedure

The section will use a five core wire as a sample, single core wire has same connection process
 Table 5-1 Recommend AC cable size

Module \ Type	Cable cross-sectional area of L/N(mm ²)	Cable cross-sectional area of P/E(mm ²)	multi-core cable O.D. range(mm)	single-core cable O.D. range(mm)
SOFAR 100~125KTLX-G4	Copper Wire:95~185 Aluminum Wire:120~240	16~35	≤60	≤32

Step 1: Open the cover, refers to section 5.4.1.

Step 2: Turn OFF the AC circuit breaker and secure against reconnection.

Step 3: Unscrew the nut of the AC terminal block and select the sealing ring according to the outer diameter of the cable. Insert the nut, sealing ring into the cable in sequence.

Step 4: Remove the insulation layer of an appropriate length according to figure below.

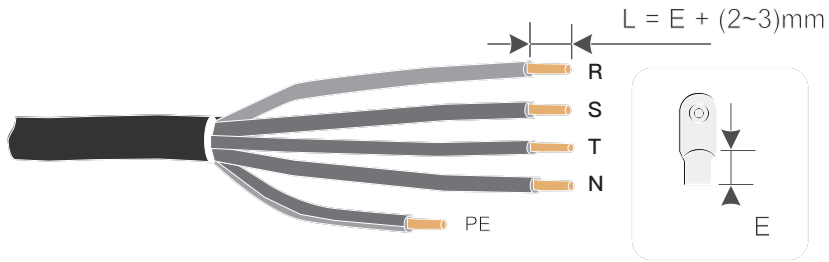

Step 5: Crimp the Terminal.

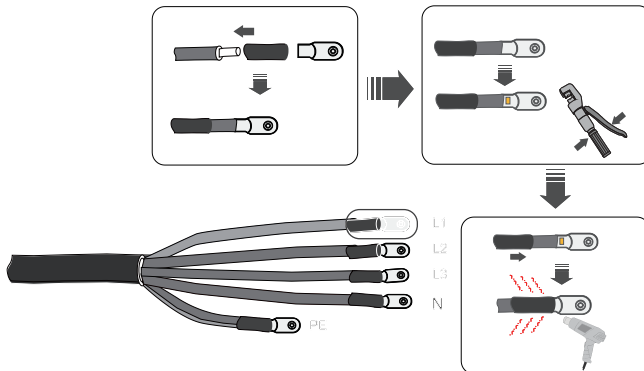

Step 6: Depending on the grid configuration, connect L1, L2, L3 and N to the terminals according to the label and tighten the screw on the terminal using a screwdriver.

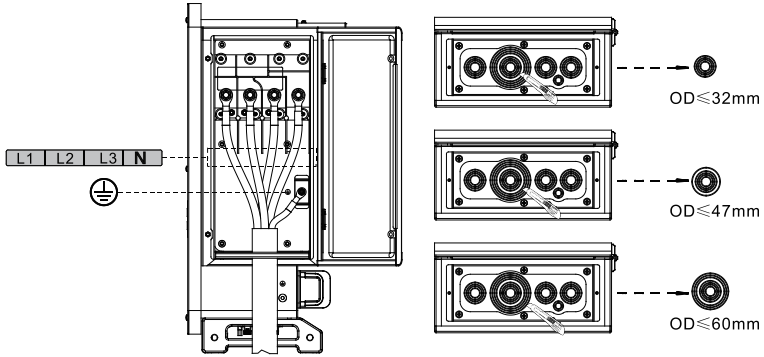

single core cable is wired as follows:

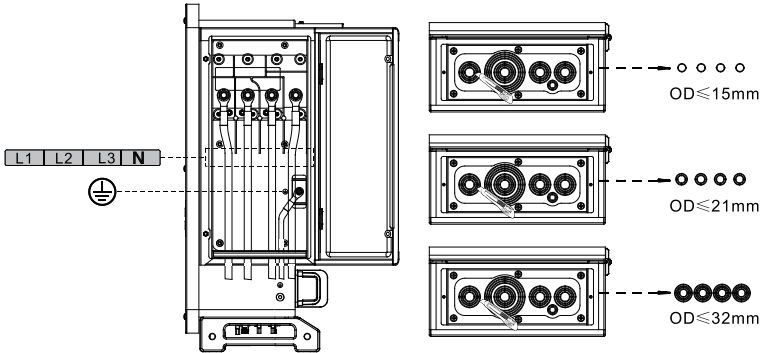

Note: Phase lines use M12 terminal connector, PE line use M8 terminal connector. The position of “PE” Line and “N” Line should not be opposite. Opposite position may cause inverter permanently faulty.

Step 7: Closed wiring box cover, and tighten the screw.

5.5 Connect PV Side Of Inverter(DC-Input)

Note:

- Connecting PV strings into inverter must following the below procedure. Otherwise, any faulty cause by inappropriate operation will be including in the warranty case.
- Ensure the maximum short circuit current of PV strings should less than the maximum inverter DC current input. And three “DC switch” is in OFF position. Otherwise, it may cause high voltage and electric shock.
- Ensure PV array have good insulation condition in any time.
- Ensure same PV string should have the same structure, including: same model, same number of panels, same direction, same azimuth.
- Ensure PV positive connector connect to inverter positive pole, negative conenctor connect to inverter negative pole
- Please use the connectors in the accessories bag. The damage cause by incorrect is not including in the warranty.

Table 5-2 Recommend DC cable size

Copper cable cross section area (mm ²)		Cable OD(mm)
Range	Recommend	
4.0~6.0	4.0	4.5~7.8

Step 1: Find the metal contact pins in the accessories bag, connect the cable according below diagram (1.Positive cable, 2. negative cable);

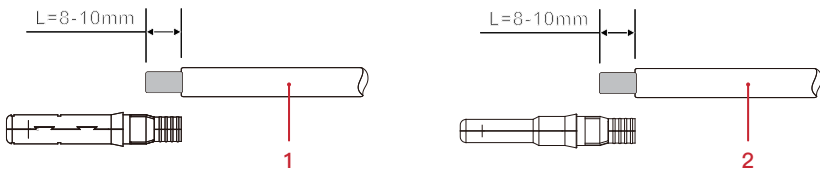
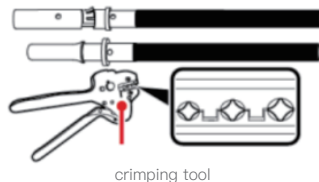

Figure 5-8 DC cable connection (1)

Step 2: Crimp the PV metal contact pin to the striped cable using a proper crimping pliers;



crimping tool

Step 3: Insert wire into the connector cap nut and assemble into the back of male or female plug, When you heard a “click”, the pin tact assembly is seated correctly. (3. Positive connector, 4. Negative connector);

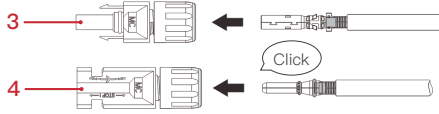

Step 4: Measure PV voltage of DC input with multimeter, verify DC input cable polar and connect DC connector with inverter until hearing a slight sound indicated connection succeed (5. Positive cable, 6. Negative cable).

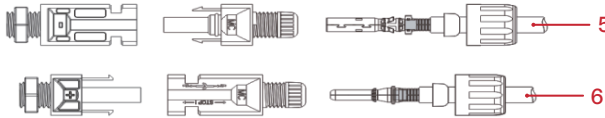
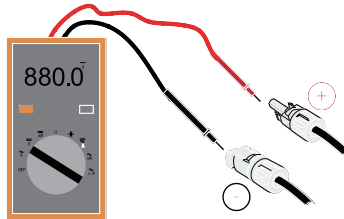

Figure 5-9 DC cable connection



Note: Please use multimeter to make sure the PV array positive pole and negative pole!

Dealing: If need to remove the PV connector from inverter side, please use the Removal Tool as below diagram, move the connector gently.



Note

Before, moving the positive and negative connector, please make sure “DC Switch” is on OFF position.

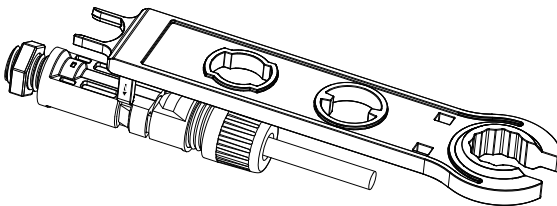

Figure 5-10 Removal DC connector

5.6 Communication Connection

Note: When layout the wiring diagram, please separate the communication wiring and power wiring in case the signal be affected.

5.6.1 USB/WIFI Port

Port Description:

USB/WIFI port	USB: USB PORT	Use for updating the software
	WIFI: WIFI PORT	Use for connect WIFI for data transmission

Procedure:

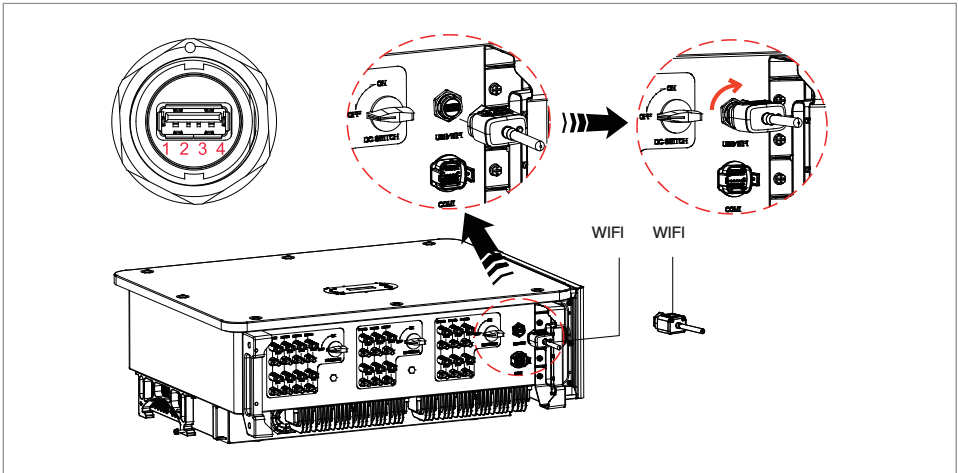

WIFI

By the USB acquisition stick (WiFi), transfer the inverter power output information, alarm information, operation state to the PC terminal or local data acquisition device, then uploaded to the server. Register remote monitoring of SOFAR 100~125KTLX-G4 at its relevant website or APP according to monitoring device SN.

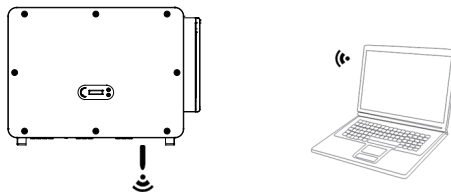

Figure 5-11 Connect one USB acquisition stick (WiFi version) to wireless router

5.6.2 COM—Multi function communication port

Table 5-3 Recommend com cable size

Name	Type	Outer diameter(mm)	Area(mm ²)
RS485 Communication Wire	Outdoor shielded twisted pair meets local standards	3core: 4~8	0.25~1

Port Description:

COM1:

PIN	Define	Function	Note
1	RS485A	RS485 signal+	Wire connection monitoring or multiple inverter monitoring
2	RS485A	RS485 signal+	
3	RS485B	RS485 signal-	
4	RS485B	RS485 signal-	
5	Electric meter RS485A	Electric meter RS485 signal+	Wire connection Electric meter
6	Electric meter RS485B	Electric meter RS485 signal-	
7	GND.S	RS485 signal ground	DRMS port
8	DRM0	Remote shunt down	
9	DRM1/5		
10	DRM2/6		
11	DRM3/7		
12	DRM4/8		
13	GND.S	Communication Ground	
14-16	Blank PIN	N/A	N/A

Procedure :

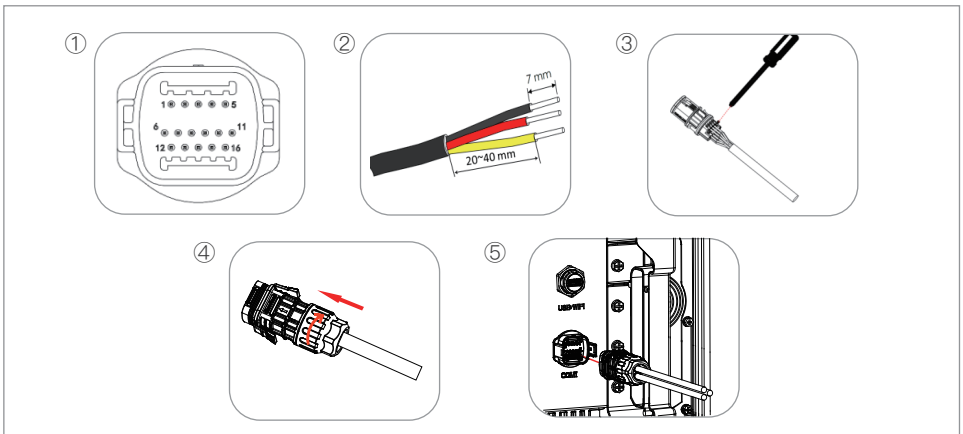

Communications Port Description

Logic interface

A. Logic interface for AS/NZS 4777.2:2020, also known as inverter demand response modes (DRMs).

The inverter will detect and initiate a response to all supported demand response commands within 2 s. The inverter will continue to respond while the mode remains asserted.

Table 5-4 Function description of the DRMs terminal

PIN	Function
9	DRM1/5
10	DRM2/6
11	DRM3/7
12	DRM4/8
13	GND
8	DRM0

NOTE: Supported DRM command: DRM0, DRM5, DRM6, DRM7, DRM8.

B. Logic interface for AS/NZS 4777.2:2020, also known as inverter demand response modes (DRMs).

The inverter will detect and initiate a response to all supported demand response commands within 2 s. The inverter will continue to respond while the mode remains asserted.

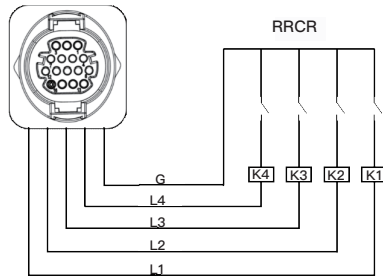

Figure 5-12 Inverter – RRCR Connection

Table 5-5 Function description of the terminal

PIN	Pin name	Description	Connected to (RRCR)
9	L1	Relay contact 1 input	K1 – Relay 1 output
10	L2	Relay contact 2 input	K2 – Relay 2 output
11	L3	Relay contact 3 input	K3 – Relay 3 output
12	L4	Relay contact 4 input	K4 – Relay 4 output
13	G	GND	Relays common node

Table 5-6 The inverter is preconfigured to the following RRCR power levels
Relay status: close is 1, open is 0

L1	L2	L3	L4	Active Power	cos(φ)
1	0	0	0	0%	1
0	1	0	0	30%	1
0	0	1	0	60%	1
0	0	0	1	100%	1

C. Logic interface for EN50549-1:2019, is in order to cease active power output within five seconds following an instruction being received at the input interface.

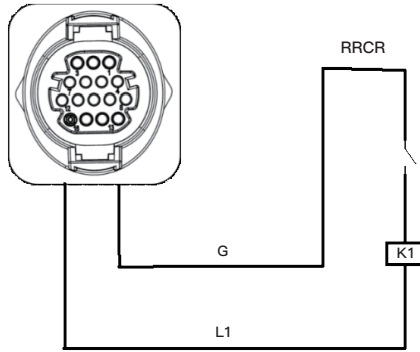

Figure 5-13 Inverter – RRCR Connection

Table 5-7 Function description of the terminal

PIN	Pin name	Description	Connected to (RRCR)
9	L1	Relay contact 1 input	K1 – Relay 1 output
13	G	GND	K1 – Relay 1 output

Table 5-8 The inverter is preconfigured to the following RRCR power levels.
Relay status: close is 1, open is 0

L1	Active Power	Power drop rate	cos(φ)
1	0%	<5 seconds	1
0	100%	/	1

RS485

By RS485 interface, transfer the inverter power output information, alarm information, operation state to the PC terminal or local data acquisition device, then uploaded to the server.

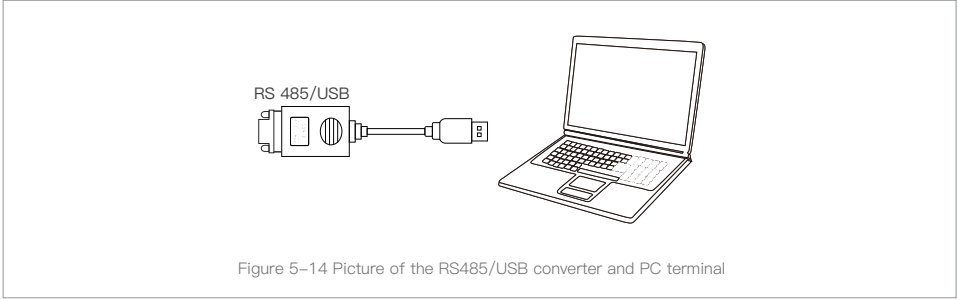

If only one SOFAR 100~125KTLX-G4 is used, use a communication cable, refer to section 5.6.2 for COM pin definition, and choose either of the two RS485 ports.

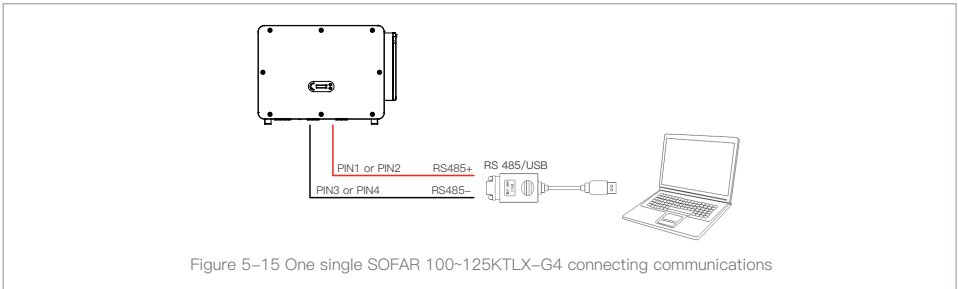

 Note	<p>The length of the RS485 communication cable should be less than 1000 m.</p> <p>The length of the WiFi communication cable should be less than 100 m.</p>
----------------------------------------------------------------------------------------------------	-------------------------------------------------------------------------------------------------------------------------------------------------------------

6. Commissioning of inverter

Outlines this Chapter

Introduce SOFAR 100~125KTLX-G4 safety inspection and start processing

6.1 Cable Connection Inspection



Attention

For first time operation, check the AC voltage and DC voltage are within the acceptable range

AC grid connection

Use multimeter to confirm that three lines and PE line are connect correctly.

DC PV connection.

Use multimeter to confirm that positive pole and negative pole of PV strings, and the Voc of each string is lower than the inverter max DC input.

6.2 Start Inverter

Step 1: Turn ON the DC switch.

Step 2: Turn ON the AC circuit breaker.

When the DC power generated by the solar array is enough, the SOFAR 100~125KTLX-G4 inverter will start automatically. Screen showing “normal” indicates correct operation.

NOTE 1: Choose the correct country safety code.

NOTE 2: Different distribution network operators in different countries have different requirements regarding grid connections of PV grid connected inverters.

Therefore, it's very important to make sure that you have selected the correct country code according to requirements of local authority. Please consult qualified electrical engineer or personnel from electrical safety authorities about this.

Shenzhen SOFARSOLAR Co., Ltd. is not responsible for any consequences arising out of incorrect country code selection.

If the inverter indicates any fault, please refer to Section 8.1 of this manual — trouble shooting for help.

7.Operation interface

Outlines of this chapter

This section introduces the display, operation, buttons and LED indicator lights of SOFAR 100~125KTLX-G4 Inverter.

7.1 Operation and Display Panel

Buttons and Indicator lights

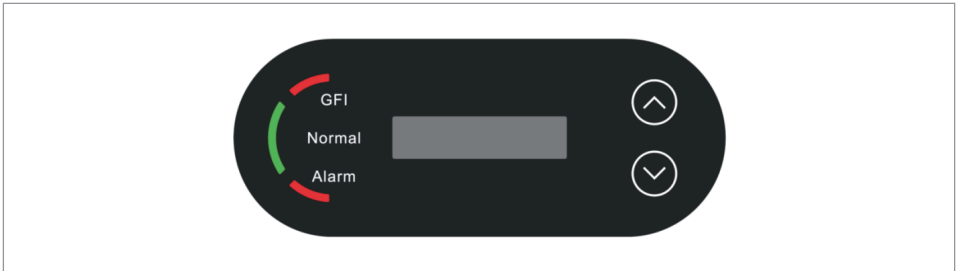

Button:

“^” Short press UP button = go up; “^” Long press UP button = exit current interface;
 “v” Short press DOWN button = go down; “v” Long press DOWN button = enter current interface

Indicator Lights:

“GFI” Red light ON = GFCI faulty; “Normal” Green light flashing = counting down or checking
 “Normal” Green light ON = Normal; “Alarm” Red light ON= recoverable or unrecoverable faulty

7.2 Standard Interface

LCD interface indicated inverter status, alarm information, communication connection, PV input current and voltage, grid voltage,current and frequency, today generation, total generation.

1.Inverter working status, PV 1 -12 PV input voltage and current



2.Inverter working status, PV generated power



3. Inverter working status, today generated electricity

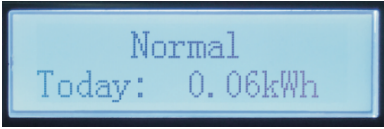

4. Inverter working status, total generated electricity

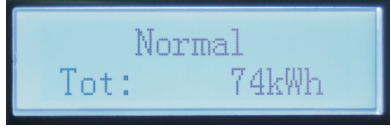

5. Inverter working status, grid voltage and current

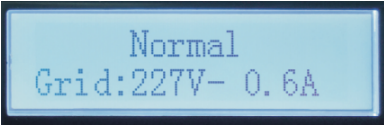

6. Inverter working status, grid voltage and frequency

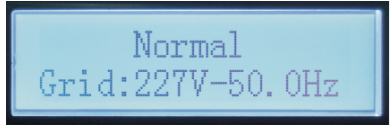

7. Inverter working status, WiFi/ RS485 status

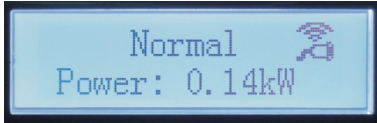

8. Inverter faulty alarm



9. When power turn on, LCD interface displays INITIALIZING, refer below picture



10. When control board successfully connected with communication board, the LCD display the current state of the inverter, display as shown in the figure below.

wait 10s	Waiting states ,Countdown 10S (depends country code some are 60s)	normal	normal power generation
check	checking	permanent	unrecoverable error state
fault	regular error state		

Inverter states includes: wait, check, normal, fault and permanent

Wait: Inverter is waiting to Check State when reconnect the system. In this state, grid voltage value is between the max and min limits and so on; If not, Inverter will go to Fault State or Permanent State.

Check: Inverter is checking isolation resistor, relays, and other safety requirements. It also does self-test to ensure inverter software and hardware are well functional. Inverter will go to Fault State or Permanent State if any error or fault occurs.

Normal: Inverter enter to Normal State, it is feeding power to the grid; inverter will go to Fault State or Permanent state if any error or fault occurs.

Fault: Fault State: Inverter has encountered recoverable error. It should recover if the errors disappear. If Fault State continues; please check the inverter according error code.

Permanent: Inverter has encountered unrecoverable error, we need maintainer debug this kind of error according to error code.

11. When the control board and communication board connection fails, the LCD display interface as shown in the figure below.

DSP communicate fail

7.3 Main Interface

Long press the down button under standard interface to enter into main interface, Main interface including below information: :

Normal	Long press DOWN button	
	1. Enter Setting	
	2. Event List	
	3. SystemInfo	
	4. Display Time	
5. Software Update		

A. Enter setting Interface as below:

Enter Setting	Long press DOWN button		
	1. Set time	8. Set input mode	15. PCC Select
	2. Clear Energy	9. Set Language	16. PID Setting
	3. Clear Events	10. Set Anti Reflux	17. Set Baud
	4. Set SafeCode	11. Hard Reflux	18. GroundDetection
	5. Remote Control	12. Logic Interface	19. AFCI Setting
	6. Set Energy	13. IV Curve Scan	20. InputSafety
7. Set Address	14. Set Power Derating	21. SetSafety	

Long press the button to Enter the main interface of "1.Enter Setting" and long press to enter the setting menu. You can select the content you want to set by short pressing the button.

Note1: Some settings need to enter the password (the default password is 0001), when entering the password, short press to change the number, long press to confirm the current number, and long press after entering the correct password.If "password error, try again" appears, you will need to re-enter the correct password.

1.Set Time

Set the system time for the inverter.

2.Clear Energy

Clean the inverter of the total power generation.

3.Clear Events

Clean up the historical events recorded in the inverter.

4.Set SafeCode

Long press button, enter interface, save the specific file into USB and insert USB into inverter communication port.

5.Remote Control

Inverter on-off remote control.

6.Set Energy

Set the total power generation. You can modify the total power generation through this option.

7.Set address

Set the address (when you need to monitor multiple inverters simultaneously), Default 01.

8.Set Input mode

SOFAR 100~125KTLX-G4 has 10 MPPTs, these MPPTs can work interdependently, or divided into parallel mode. User can change the setting according to the configuration.

9.Set Language

Set the inverter display language.

10.Set Anti Reflux

Long-press the down button to enter the RefluxP enable selection interface (enter the default password: 0001), and then Long-press the down button to enter the reverse-current power setting interface, and you can enter the reverse-current power percentage. Long press the up button to exit the setting interface.

The reflux power value set by the anti-reflux function is the maximum power value allowed to be transmitted to the grid.

11.Hard Reflux

Set hard anti-reflux switch and percentage.

12.Logic interface

Enable or disable logical interfaces. It is use for below standard Australia (AS4777), Europe General (50549), German(4105).

13.IV Curve Scan

Shadow scanning, when the component is blocked or abnormal, causing multiple power peaks, by enabling this function, the peak point of maximum power can be tracked.

14.Set Power Derating

Set active load shedding function switch , percentage load shedding.

15.PCC Select

Select the parallel network sampling method.

16.PID

Enable or disable PID function. When the PID module is enabled(enter the default password: 0001),it will work between 0 a.m. and 4 a.m.

17.Set Baud

Select the protocol type and set the baud rate.

18.GroundDetection

Set ground detection protection

19.AFCI Setting

Turn on the AFCI detection function.

20.InputSafety

Put the safety library upgrade file "125KW-G4_SAFETY.bin" in the root directory/ firmware folder of the USB flash drive and insert the USB flash drive into the inverter. The upgrade will take place automatically after the inverter is enabled.

21.SetSafety

Press the up and down keys to select the safety standard region, press and hold the down key to enter the standard selection under the region, and then turn the page to select the safety standard.

B.Event List:

Event List is used to display the real-time event records, including the total number of events and each specific ID No. and happening time. User can enter Event List interface through main interface to check details of real-time event records, Event will be listed by the happening time, and recent events will be listed in the front.

Please refer to below picture. Long press the button and short press the button to turn the page in standard interface, then enter into “2.Event List” interface.

Event List	
1. Current event	2. History event
Fault information	001 ID04 06150825(Display the event sequence number, event ID number, and event occurrence time)

C.“SystemInfo” Interface as below

SystemInfo	Long press DOWN button		
	1.Inverter Type	8.Modbus Address	15.Mppt Scan
	2.Serial Number	9.Input Mode	16.Active Power
	3.General Soft Version	10.Remote State	17.PCC Select
	4.General Hard Version	11.Reflux Enable	18. Power Ration
	5.Safety	12.Reflux Power	19. GroundDetection
	6.SafetySWVer	13.DRMs0	
	7.Safety Hardver	14.DRMn	

The user enters the main menu by long pressing the DOWN button, short press and turns the page to select menu contents, then long press the button to enter ”3. SystemInfo”. Turning the page down can select the system information to view.

D.Display Time

Long press the button and short press the button to turn the page in the standard user interface to enter into “4.Display Time”,then long press the button to display the current system time.

E.Software Update

User can update software by USB flash drive , SOFARSOLAR will provide the new update software called firmware for userif it is necessary,The user needs to copy the upgrade file to the USB flash drive.

7.4 Updating Inverter Software

SOFAR 100~125KTLX-G4 inverter offer software upgrade via USB flash drive to maximize inverter performance and avoid inverter operation error caused by software bugs.

Step 1: Turn off AC circuit breaker and DC switch, remove the communication board cover as below figure. If the RS485 line has been connected, please release the waterproof nut first and make sure the communication line is no longer the force. Then remove the waterproof cover.

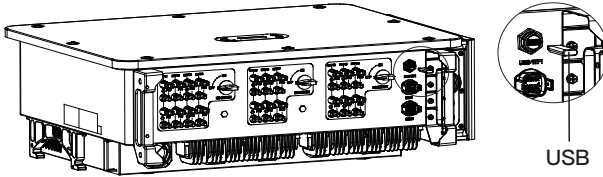

Figure 7-1 Remove communication board cover

Step 2: Insert USB into computer;

Step 3: SOFARSOLAR service team will send the software code to user, After user receive the file, please decompressing file and cover the original file in USB flash drive.

Step 4: Insert USB drive into the USB port of inverter;

Step 5: Then turn on DC switch and enter into the online upgrade to the main menu "5. Software Update" in the LCD display program [6.3(E)]. The method to enter the menu can refer to operation interface of LCD.

Step 6: Input the password, if password is correct, and then begin the update process, the original password is 0715.

Step 7: System update main DSP, slave DSP and ARM in turns. If main DSP update success, the LCD will display "Update DSP1 Success", otherwise display "Update DSP1 Fail"; if slave DSP update success, the LCD will display "Update DSP2 Success", otherwise display "Update DSP2 Fail".

Step 8: If Fail, please turn off the DC switch, wait for the LCD screen turn off, then turn on the DC switch again, then Continue to update from step 5.

Step 9: After the update is completed, turn off the DC breaker, wait for the LCD screen extinguish, then recover the communication waterproof and then turn on the

DC breaker and AC breaker again, the inverter will enter the running state. User can check the current software version in SystemInfo >> 3. SoftVersion.

8. Trouble shooting and maintenance

8.1 Troubleshooting

This section describes the potential errors for this product. Please read carefully for the following tips when doing the troubleshooting:

1) Check the warning message or faulty codes on the inverter information panel

2) If not any error code display on the panel, please check the following lists:

- Is inverter be installed in a clean, dry, ventilated environment?
- Is the DC switch turn off?
- Are the cable cross section area and length meet the requirement?
- Are the input and output connection and wiring in good condition?
- Are the configuration settings correctly for the particular installation?

This section contains the potential errors, resolution steps, and provide users with troubleshooting methods and tips

The process to check the event list can refers to Manual Chapter 7.3 (B)

Table 8-1 Even list

Code	Name	Description	Solution
ID001	GridOVP	The grid voltage is too high	If the alarm occurs occasionally, the possible cause is that the electric grid is abnormal occasionally. Inverter will automatically return to normal operating status when the electric grid's back to normal. If the alarm occurs frequently, check whether the grid voltage/frequency is within the acceptable range. If yes, please check the AC circuit breaker and AC wiring of the inverter. If the grid voltage/frequency is NOT within the acceptable range and AC wiring is correct, but the alarm occurs repeatedly, contact technical support to change the grid over-voltage, under-voltage, over-frequency, under-frequency protection points after obtaining approval from the local electrical grid operator.
ID002	GridUVP	The grid voltage is too low	
ID003	GridOFF	The grid frequency is too high	
ID004	GridUFP	The grid frequency is too low	
ID005	GFCI	Charge Leakage Fault	Check for inverter and wiring.
ID006	OVRT	OVRT function is faulty	If the alarm occurs occasionally, the possible cause is that the electric grid is abnormal occasionally. Inverter will automatically return to normal operating status when the electric grid's back to normal.
ID007	LVRT	LVRT function is faulty	
ID008	IslandFault	Island protection error	If the alarm occurs frequently, check whether the grid voltage/frequency is within the acceptable range. If yes, please check the AC circuit breaker and AC wiring of the inverter. If the grid voltage/frequency is NOT within the acceptable range and AC wiring is correct, but the alarm occurs repeatedly, contact technical support to change the grid over-voltage, under-voltage, over-frequency, under-frequency, under-voltage, over-voltage, over-frequency,
ID009	GridOVPlntant1	Transient overvoltage of grid voltage 1	
ID010	GridOVPlntant2	Transient overvoltage of grid voltage 2	

Code	Name	Description	Solution	
ID011	VGridLineFault	Power grid line voltage error	under-frequency protection points after obtaining approval from the local electrical grid operator.	
ID012	InvVoltFault	Inverter voltage error	Internal faults of inverter, switch OFF inverter, wait for 5 minutes, then switch ON inverter. Check whether the problem is solved. If no, please contact technical support.	
ID013	RefluxFault	Anti-countercurrent overload		
ID014	VGridUnbalance	grid voltage imbalance		
ID017	HwADerrGrid	Power grid current sampling error		
ID018	HwADerrDCI(AC)	Wrong sampling of dc component of grid current		
ID019	HwADerrVGrid(DC)	Power grid voltage sampling error (DC)		
ID020	HwADerrVGrid(AC)	Power grid voltage sampling error (AC)		
ID021	HwGFCIFault(DC)	Leakage current sampling error(DC)		
ID022	HwGFCIFault(AC)	Leakage current sampling error(AC)		
ID024	HwADerrldc	Dc input current sampling error		
ID025	HwADerrDCI(DC)	\		
ID026	HwADerrldcBranch	\		
ID029	ConsistentGFCI	Leakage current consistency error		Internal faults of inverter, switch OFF inverter, wait for 5 minutes, then switch ON inverter. Check whether the problem is solved. If no, please contact technical support.
ID030	ConsistentVgrid	Grid voltage consistency error		
ID031	ConsistentDCI	DCI consistency error		
ID033	SpiCommFault(DC)	SPI communication error (DC)		
ID034	SpiCommFault(AC)	SPI communication error (AC)		
ID035	SChip_Fault	Chip error (DC)		
ID036	MChip_Fault	Chip error (AC)		

Code	Name	Description	Solution
ID037	HwAuxPowerFault	Auxiliary power error	
ID038	InvSoftStartFail	Inverter soft startup failed	
ID039	ArcShutdownAlarm	Arc shutdown protection	Check whether the photovoltaic module connection line and terminals have bad arc contact. If there is a fault, please repair the fault in time.
ID041	RelayFail	Relay detection failure	Internal faults of inverter, switch OFF inverter, wait for 5 minutes, then switch ON inverter. Check whether the problem is solved. If no, please contact technical support.
ID042	IsoFault	Low insulation impedance	Check the insulation resistance between the photovoltaic array and ground (ground), if there is a short circuit, the fault should be repaired in time.
ID043	PEConnectFault	Ground fault	Check ac output PE wire for grounding.
ID044	PvConfigError	Error setting input mode	Check the input mode (parallel/independent mode) Settings for the inverter. If not, change the input mode.
ID046	ReversalConnect	PV input polarity reverse connection error	Connect the PV assembly according to the correct polarity.
ID050	TempErrHeatSink1	Radiator 1 temperature protection	For Inner BMS battery, make sure that the battery NTC cable is properly connected. Make sure the inverter is installed where there is no direct sunlight. Please ensure that the inverter is installed in a cool/well ventilated place. Ensure the inverter is installed vertically and the ambient temperature is below the inverter temperature limit.
ID051	TempErrHeatSink2	Radiator 2 temperature protection	
ID052	TempErrHeatSink3	Radiator 3 temperature protection	
ID053	TempErrHeatSink4	Radiator 4 temperature protection	
ID054	TempErrHeatSink5	Radiator 5 temperature protection	
ID055	TempErrHeatSink6	Radiator 6 temperature protection	
ID057	TempErrEnv1	Ambient temperature 1 protection	
ID058	TempErrEnv2	Ambient temperature 2 protection	
ID059	TempErrInv1	Module 1 temperature protection	
ID060	TempErrInv2	Module 2 temperature protection	

Code	Name	Description	Solution
ID061	TempErrInv3	Module 3 temperature protection	
ID062	TempDiffErrInv	Inverter Module Temperature Difference is too large	
ID065	BusRmsUnbalance	Unbalanced bus voltage RMS	Internal faults of inverter, switch OFF inverter, wait for 5 minutes, then switch ON inverter. Check whether the problem is solved. If no, please contact technical support.
ID066	BusInstUnbalance	The transient value of bus voltage is unbalanced	
ID067	BusUVP	Busbar undervoltage during grid-connection	
ID068	BusZVP	Bus voltage low	
ID069	PVOVP	PV over-voltage	Check whether the PV series voltage (Voc) is higher than the maximum input voltage of the inverter. If so, adjust the number of PV modules in series and reduce the PV series voltage to fit the input voltage range of the inverter. After correction, the inverter will automatically return to its normal state.
ID071	LLCBusOVP	LLC BUS overvoltage protection	Internal faults of inverter, switch OFF inverter, wait for 5 minutes, then switch ON inverter. Check whether the problem is solved. If no, please contact technical support.
ID072	SwBusRmsOVP	Inverter bus voltage RMS software overvoltage	
ID073	SwBusIOVP	Inverter bus voltage instantaneous value software overvoltage	
ID082	DciOCP	Dci overcurrent protection	
ID083	SwIOCP	Output instantaneous current protection	
ID084	SwBuckBoostOCP	BuckBoost software flow	
ID085	SwAcRmsOCP	Output effective value current protection	
ID086	SwPvOCPInstant	PV overcurrent software protection	
ID087	IpvUnbalance	PV flows in uneven parallel	
ID088	IacUnbalance	Unbalanced output current	
ID089	SwPvOCP	PV overcurrent software protection	

Code	Name	Description	Solution
ID090	lbalanceOCP	Inverter bus balance current protection	
ID091	SwAcCBCFault	Software AC Over Current Protection	
ID098	HwBusOVP	Inverter bus hardware overvoltage	
ID099	HwBuckBoostOCP	BuckBoosthardware overflows	
ID102	HwPVOCP	PV hardware overflows	
ID103	HwACOCP	Ac output hardware overflows	
ID104	HwDiffOCP	Hardware differential over-current	
ID105	MeterCommFault	Meters communication fault	Check whether the meters wiring is correct.
ID113	OverTempDerating	Internal temperature is too high	Make sure the inverter is installed where there is no direct sunlight. Please ensure that the inverter is installed in a cool/well ventilated place. Ensure the inverter is installed vertically and the ambient temperature is below the inverter temperature limit.
ID114	FreqDerating	AC frequency is too high	Please make sure the grid frequency and voltage is within the acceptable range.
ID115	FreqLoading	AC frequency is too low	
ID116	VoltDerating	AC voltage is too high	
ID117	VoltLoading	AC voltage is too low	
ID129	PermHwAcOCP	Output hardware overcurrent permanent failure	Internal faults of inverter, switch OFF inverter, wait for 5 minutes, then switch ON inverter. Check whether the problem is solved. If no, please contact technical support.
ID130	PermBusOVP	Permanent Bus overvoltage failure	
ID131	PermHwBusOVP	Permanent Bus hardware overvoltage failure	
ID132	PermplpvUnbalance	PV uneven flow permanent failure	

Code	Name	Description	Solution
ID134	PermAcOCPIinstant	Output transient overcurrent permanent failure	
ID135	PermlacUnbalance	Permanent failure of unbalanced output current	
ID137	PermlnCfgError	Input mode setting error permanent failure	Check the PV input mode (parallel/independent mode) Settings for the inverter. If not, change the PV input mode.
ID138	PermDCOCPIinstant	Input overcurrent permanent fault	
ID139	PermHwDCOCP	Input hardware overcurrent permanent failure	Internal faults of inverter, switch OFF inverter, wait for 5 minutes, then switch ON inverter. Check whether the problem is solved. If no, please contact technical support.
ID140	PermRelayFail	Permanent relay failure	
ID141	PermBusUnbalance	Bus voltage unbalanced permanent failure	
ID142	PermSpdFail(DC)	PV surge protection	
ID143	PermSpdFail(AC)	Grid surge protection	
ID145	USBFault	USB fault	Check the USB port of the inverter
ID146	WifiFault	WiFi fault	Check the WiFi port of the inverter
ID147	BluetoothFault	Bluetooth fault	Check the bluetooth connection of the inverter
ID148	RTCFault	RTC clock failure	Internal faults of inverter, switch OFF inverter, wait for 5 minutes, then switch ON inverter. Check whether the problem is solved. If no, please contact technical support.
ID149	CommEEPROMFault	Communication board EEPROM error	
ID150	FlashFault	Communication board FLASH error	
ID152	SafetyVerFault	The software version is inconsistent with the safety version	
ID153	SCILose(DC)	SCI communication error (DC)	
ID154	SCILose (AC)	SCI communication error (AC)	
ID155	SCILose (Fuse)	SCI communication error (Fuse)	
ID156	SoftVerError	Inconsistent software versions	
ID161	ForceShutdown	Force shutdown	The inverter is performed a forced shutdown
ID162	RemoteShutdown	Remote shutdown	The inverter is performed with a Drms0 shutdown

Code	Name	Description	Solution
ID163	Drms0Shutdown	Drms0 shutdown	The inverter is performed a remote shutdown
ID165	RemoteDerating	Remote derating	The inverter is performed for remote load reduction
ID166	LogicIcfDerating	Logic interface derating	The inverter is loaded by the execution logic interface
ID167	AlarmAntiReflux	Anti refluxderating	The inverter is implemented to prevent countercurrent load drop
ID169	FanFault1	Fan 1 fault	Please check whether the fan 1 of inverter is running normally
ID170	FanFault2	Fan 2fault	Please check whether the fan 2 of inverter is running normally
ID171	FanFault3	Fan 3 fault	Please check whether the fan 3 of inverter is running normally
ID172	FanFault4	Fan 4 fault	Please check whether the fan 4 of inverter is running normally
ID173	FanFault5	Fan 5 fault	Please check whether the fan 5 of inverter is running normally
ID174	FanFault6	Fan 6 fault	Please check whether the fan 6 of inverter is running normally
ID175	FanFault7	Fan 7 fault	Please check whether the fan 7 of inverter is running normally
ID176	MeterCommLose	Meters communication fault	Check whether the meters wiring is correct
ID189	AFCICommLose	AFCI module communication is lost	
ID191	PID_Output_Fail	PID function is failed	
ID192	PLC_Com_Fail	PLC communication is lost	Check whether the meters wiring is correct

8.2 Maintenance

Inverters generally do not need any daily or routine maintenance. But ensure heat sink should not be blocked by dust, dirt or any other items. Before the cleaning, make sure that the DC SWITCH is turned OFF and the circuit breaker between inverter and electrical grid is turned OFF. Wait at least for 5 minutes before the Cleaning.

Inverter cleaning

Please clean the inverter with an air blower, a dry & soft cloth or a soft bristle brush. Do NOT clean the inverter with water, corrosive chemicals, detergent, etc.

Heat sink cleaning

For the long-term proper operation of inverters, ensure there is enough space around the heat sink for ventilation, check the heat sink for blockage (dust, snow, etc.) and clean them if they exist. Please clean the heat sink with an air blower, a dry & soft cloth or a soft bristle brush. Do NOT clean the heat sink with water, corrosive chemicals, detergent, etc.

8.3 PID Recovery

When the inverter is running, the PID function module increases the potential between the negative pole of the photovoltaic array and the ground to a positive value to suppress the PID effect.

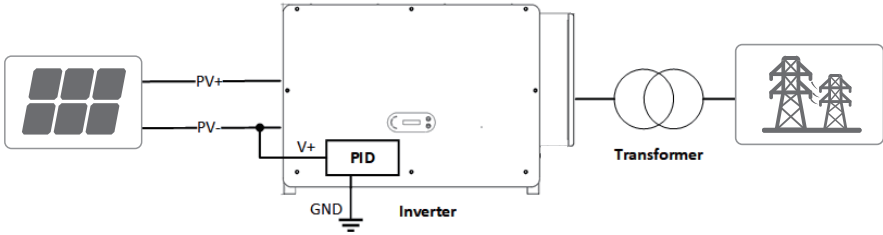

Note:

- Before enabling the PID recovery function, ensure that the polarity of the pv module's ground voltage meets requirements. If in doubt, please contact the pv module manufacturer or read their corresponding User Manual.
- If the voltage scheme of the PID protection/recovery function does not meet the requirements of the corresponding PV module, the PID function cannot work properly or may even damage the PV module.
- Before enabling the reverse PID function, ensure that the inverter has been applied to the IT system.
- When the inverter is not running, the PID module will apply reverse voltage to the photovoltaic module to restore the degraded module.
- If the PID recovery function is enabled, the PID works only at night.
- After the PID recovery function is enabled, the PV series voltage to ground is 500Vdc by default. You can change the default value through the App.

9. Technical Data

Outlines of this Chapter

This topic lists the technical specifications for SOFAR 100~125KTLX-G4 inverter.

9.1 Parameter Table:

Datasheet	SOFAR 100KTLX-G4	SOFAR 110KTLX-G4	SOFAR 125KTLX-G4	SOFAR 125KTLX-G4-A
Input (DC)				
Max. input voltage	1100V			
Rated input voltage	625V			
Start-up voltage	200V			
MPPT operating voltage range	180V~1000V			
Number of MPP trackers	10			
Number for DC inputs	20			
Max. input MPPT current	10*40A			
Max. input short circuit current	10*50A			
Output(AC)				
Rated output power	100kW	100kW	110kW	125kW
AC output power	100kVA@45°C / 90kVA@50°C	110kVA@45°C / 100kVA@50°C	125kVA@45°C / 110kVA@50°C	125kVA@45°C / 110kVA@50°C
Max. Output current	152A@380V / 145A@400V / 139.2A@415V	167.2A@380V / 159.5A@400V / 153.1A@415V	190A@380V / 181.2A@400V / 174A@415V	190A@380V / 181.2A@400V / 174A@415V
Rated grid voltage	3/N/PE, 380V / 400V / 415V			
Grid voltage range	310-480V			
Rated frequency	50/60Hz			
Grid frequency range	45~55Hz/55~65Hz			
Active power adjustable range	0~100%			
THDi	<1%(@100%P)			
Power factor	1 default (+/-0.8 adjustable)			
Efficiency				
Max efficiency	98.60%			
European efficiency	98.30%			

Protection	
DC reverse polarity protection	Yes
Anti-islanding protection	Yes
Leakage current protection	Yes
Ground fault monitoring	Yes
PV-array string fault monitoring	Yes
DC switch	Yes
PID recovery	Yes
AFCI	Yes
SPD	PV: type II standard AC: type II Standard
General Data	
Ambient temperature range	-30°C~+60°C
Topology	Transformerless
Degree of protection	IP66
Allowable relative humidity range	0~100%
Max. operating altitude	4000m(>3000m derating)
Weight	75kg
Cooling	Smart air cooling
Dimension (W × H × D)	970*695*325mm
Display	LCD & Bluetooth +APP
Communication	RS485 / WiFi

10. Quality Assurance

Standard warranty period

The standard warranty period of inverter is 60 months (5 years). There are two calculation methods for the warranty period:

Purchase invoice provided by the customer: the first flight provides a standard warranty period of 60 months (5 years) from the invoice date;

The customer fails to provide the invoice: from the production date (according to the SN number of the machine), Our company provides a warranty period of 63 months (5.25 years).

In case of any special warranty agreement, the purchase agreement shall prevail.

Extended warranty period

Within 12 months of the purchase of the inverter (based on the purchase invoice) or within 24 months of the production of the inverter (SN number of machine, based on the first date of arrival), Customers can apply to buy extended warranty products from the company's sales team by providing the product serial number, Our company may refuse to do not conform to the time limit extended warranty purchase application. Customers can buy an extended warranty of 5, 10, 15 years.

If the customer wants to apply for the extended warranty service, please contact the sales team of our company. to purchase the products that are beyond the purchase period of extended warranty but have not yet passed the standard quality warranty period. Customers shall bear different extended premium.

During the extended warranty period, PV components, WiFi and lightning protection devices are not included in the extended warranty period. If they fail during the extended warranty period, customers need to purchase and replace them from the our company.

Once the extended warranty service is purchased, our company will issue the extended warranty card to the customer to confirm the extended warranty period.

Invalid warranty clause

Equipment failure caused by the following reasons is not covered by the warranty:

- The "warranty card" has not been sent to the distributor or our company;
- Without the consent of our company to change equipment or replace parts;
- Use unqualified materials to support our company 's products, resulting in product failure;
- Technicians of non-company modify or attempt to repair and erase the product serial number or silk screen;
- Incorrect installation, debugging and use methods;
- Failure to comply with safety regulations (certification standards, etc.);
- Damage caused by improper storage by dealers or end users;
- Transportation damage (including scratches caused by internal packaging during transportation). Please claim directly from the transportation company or insurance company as soon as possible and obtain damage identification such as container/package unloading;

- Failure to follow the product User Manual, installation manual and maintenance guidelines;
- Improper use or misuse of the device;
- Poor ventilation of the device;
- The product maintenance process does not follow relevant standards;
- Failure or damage caused by natural disasters or other force (such as earthquake, lightning strike, fire, etc.)

Version 1.0



ENERGY TO POWER YOUR LIFE

ADDRESS

11th Floor, Gaoxingqi Technology Building,
District 67, Xingdong Community, Xin'an Street,
Bao'an District, Shenzhen, China

EMAIL

info@sofarsolar.com

WEBSITE

www.sofarsolar.com



301.00000344-1

